

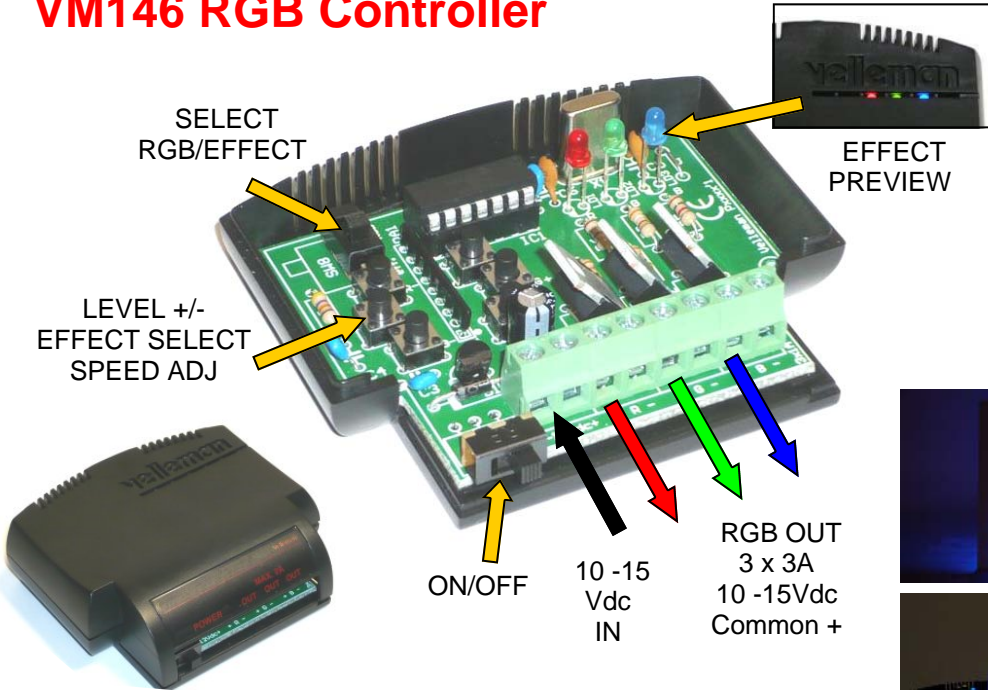

## VM146 RGB Controller

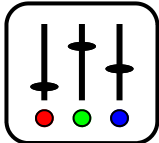

Suited for both incandescent bulbs and LEDs



Up-down level adjust for each output

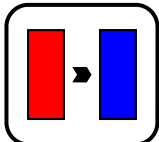

Hard transition effects  
Running light, Strobo, Colour loops, etc...

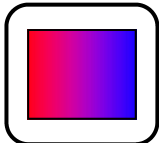

Smooth fade effects  
Colour change, flame effect, random colours, slow off etc...

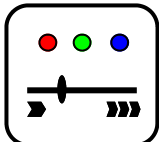

Wide-range effect speed adjust

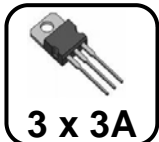

Hi power MOSFET outputs

**3 x 3A**

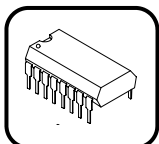

Memory for last selected effect & speed

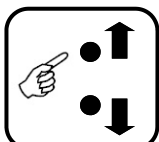

Easy up/down effect select

### Technical:

- LED PWM freq: 82Hz
- 50V/ 3A max. open drain outputs
- 256 intensity levels/ch.
- Voltage / current output:(needs optional resistor for current output)
- Power supply: 12V / 9A max.
- Dimensions: approx 80x70x23mm